

● 運転パネル

力行ノッチ

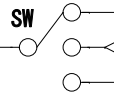

ブレーキ

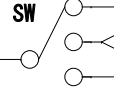

レバーサ

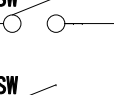

ATS復帰

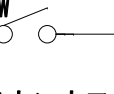

時刻表オンオフ

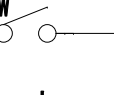

EBリセット

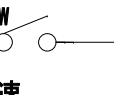

定速

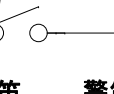

警笛

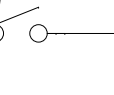

警笛選択

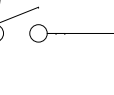

運転

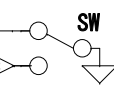

USB+5v

U2 74HC148

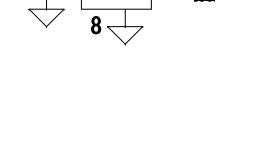
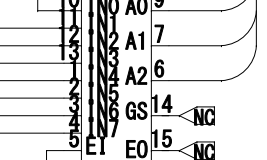
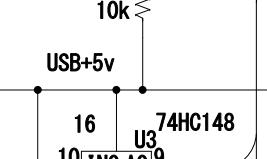
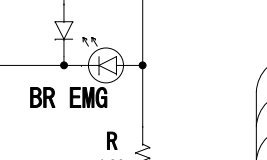
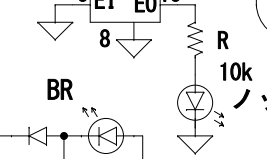
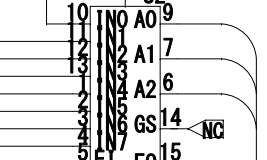

● Km2Net USB-102.0 (AKI)

VendorID 0x1352 Km2Net

ProductID 0x0121 USB-102.0 (AKI)

1000円

合計出力電流 Max 80mA

単独出力電流 Max 25mA

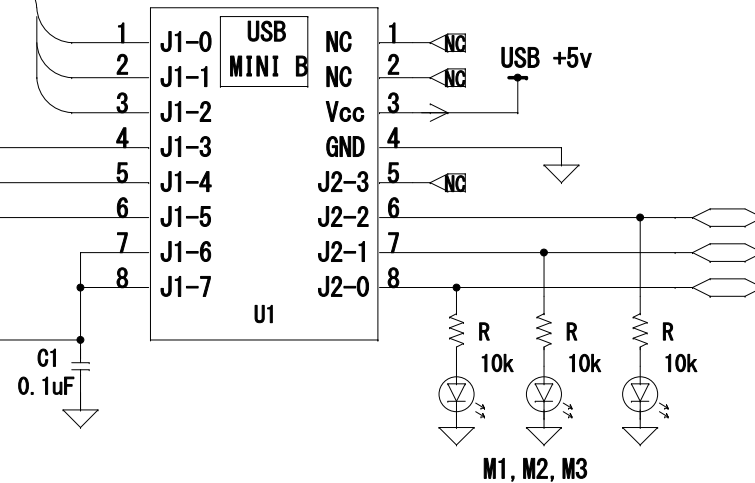

モーター用電源

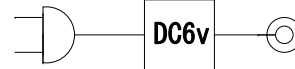

MicroSim Corporation

Usb_trgctl

220314

● 運転パネル

力行ノッチ

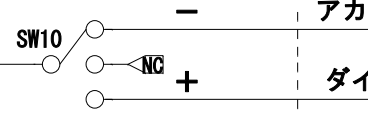

ブレーキ

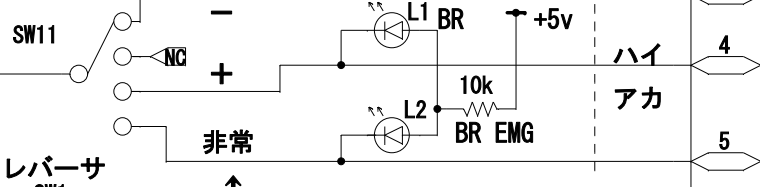

レバーサ

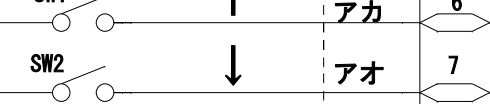

ATS復帰

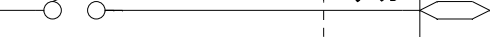

時刻表オンオフ



EBリセット



定速



警笛

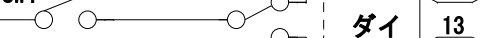

警笛選択

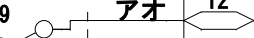

運転開始

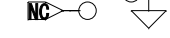

運転

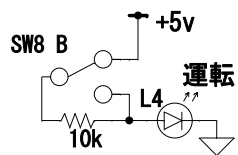

● 基板

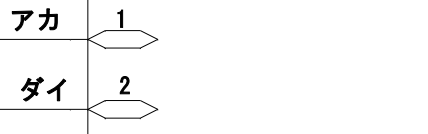

グループ ネジリ

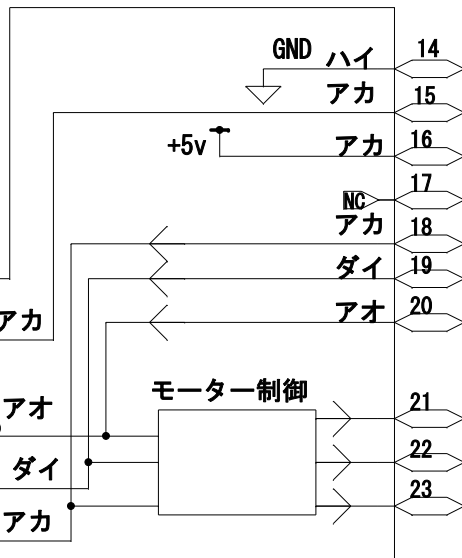

● モーター基板

モーター用電源

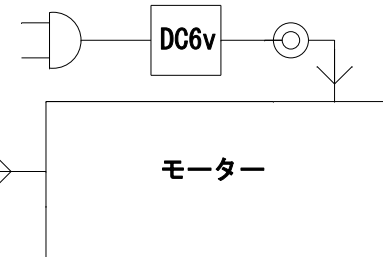

MicroSim Corporation

Usb_trgt1

220421

p2-INPUT

レバーサ

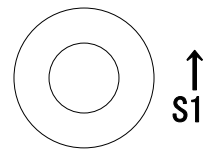

マスコン

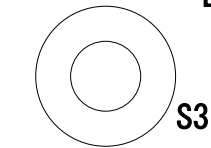
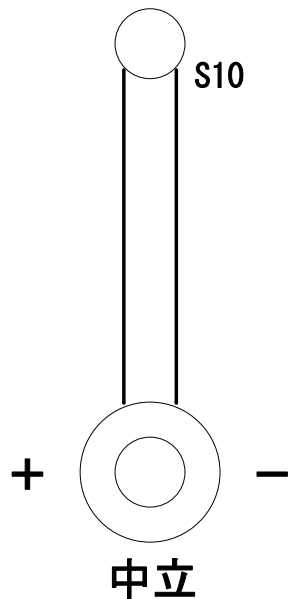

ATS復帰

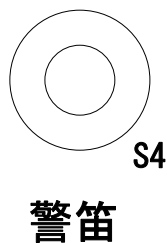

EBリセット

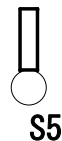

定速



時刻オンオフ

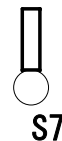

L4 運転開始



警笛選択

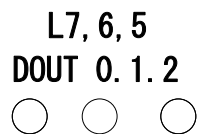
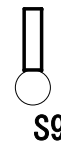

ノッチオン



ブレーキ

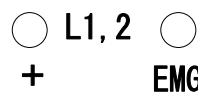

ブレーキ

